

Anaesthetic Masks

DESCRIPTION

The m|devices anaesthetic masks are colour coded for easy identification. These masks are made from transparent, non-toxic, soft PVC. The soft facial cushion provides an optimum air seal with the patient's face and the one-way valve supports efficient and easy inflation and deflation. The masks are for single use and are available in a range of Adult, Paediatric and Infant sizes. Children's masks are sweetly scented to promote calm and ease fear and anxiety.

FEATURES & BENEFITS

- Colour coded
- Children's masks are sweetly scented
- Available in Adult, Paediatric and Infant sizes
- Easy grip design

PRODUCT DATA

- Inlet diameter: 15mm (size 1-2) 22mm (size 3-6)
- Non Sterile
- Material: PVC
- Shelf Life: 5 Years
- ARTG Number: 228655

STANDARDS

- ISO 10993-1:2018 Biological evaluation of medical devices
- EN ISO 13485:2016 Medical devices - Quality management systems
- EN ISO14971:2012 Medical devices - Application of risk management to medical devices

PRODUCT DIAGRAM

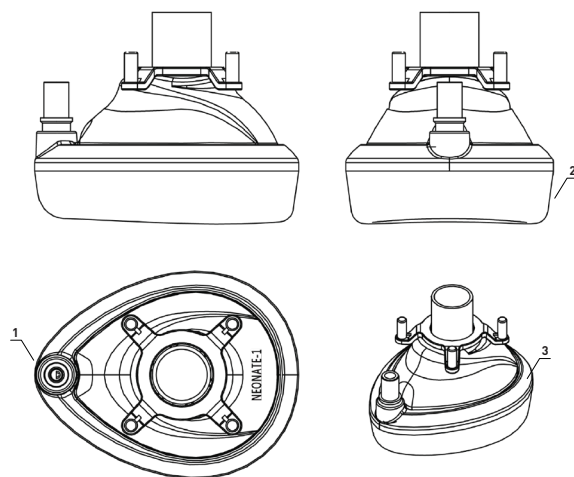

ITEM	DESCRIPTION
1	Inflation Valve One Way
2	Cushion
3	Colour Coded

AN140001NS	1	Dark Blue
AN140002NS	2	Blue
AN140003NS	3	Green
AN140004NS	4	Yellow
AN1400045NS	4.5	Orange
AN140005NS	5	Pink
AN140006NS	6	Purple

Anaesthetic Masks

Anaesthetic Masks				
RE-ORDER	DESCRIPTION	SIZE	COLOUR	CARTON/QTY
AN140001NS	Anaesthesia Mask - Neonate	1	Dark Blue	40
AN140002NS	Anaesthesia Mask - Infant - Scented	2	Blue	60
AN140003NS	Anaesthesia Mask - Child - Scented	3	Green	50
AN140004NS	Anaesthesia Mask - Small Adult	4	Yellow	40
AN140045NS	Anaesthesia Mask - Medium Adult	4.5	Orange	40
AN140005NS	Anaesthesia Mask - Adult	5	Pink	40
AN140006NS	Anaesthesia Mask - Large Adult	6	Purple	40